

AQUA GUARD

Customized
Oil Spill Response
Solutions

AQUA GUARD

▶ Made in Canada



Vancouver, British Columbia

Containment & Storage

- ▶ Protected & Calm Water Solutions
- ▶ RBS TRITON™ Technology
- ▶ Open Water Solutions
- ▶ Global Activity

▶ Harbourflex Boom

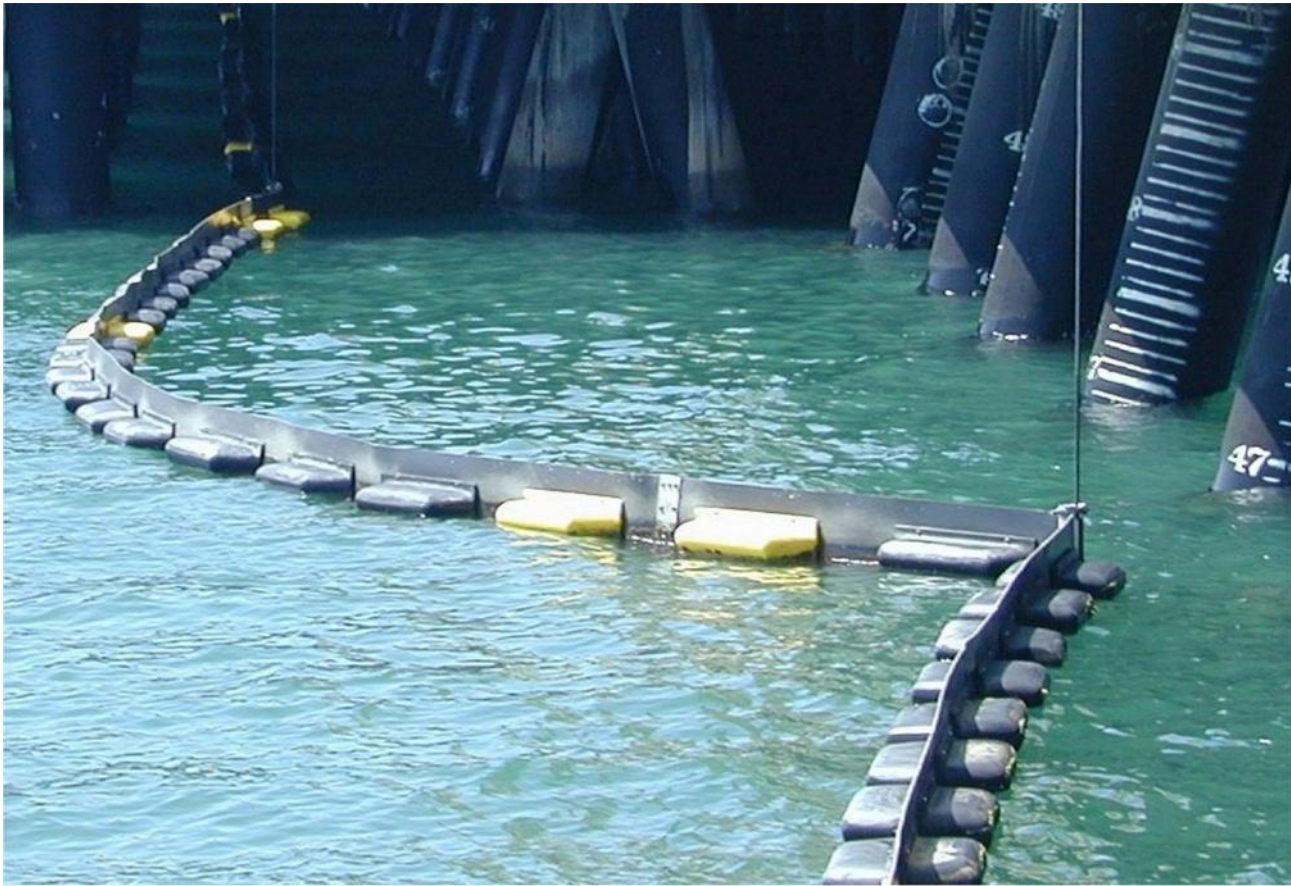

Heavy Duty, Low Maintenance

Suitable for Permanent Installation

Tidal Compensation

- Available from 18"-36" Heights (45-90cm)
- Medium to Heavy Duty Belting (150-300)
- Fasteners and Connectors are SS 304/316
- Current Installations with 25+ Years of Operation

▶ Harbourflex Boom

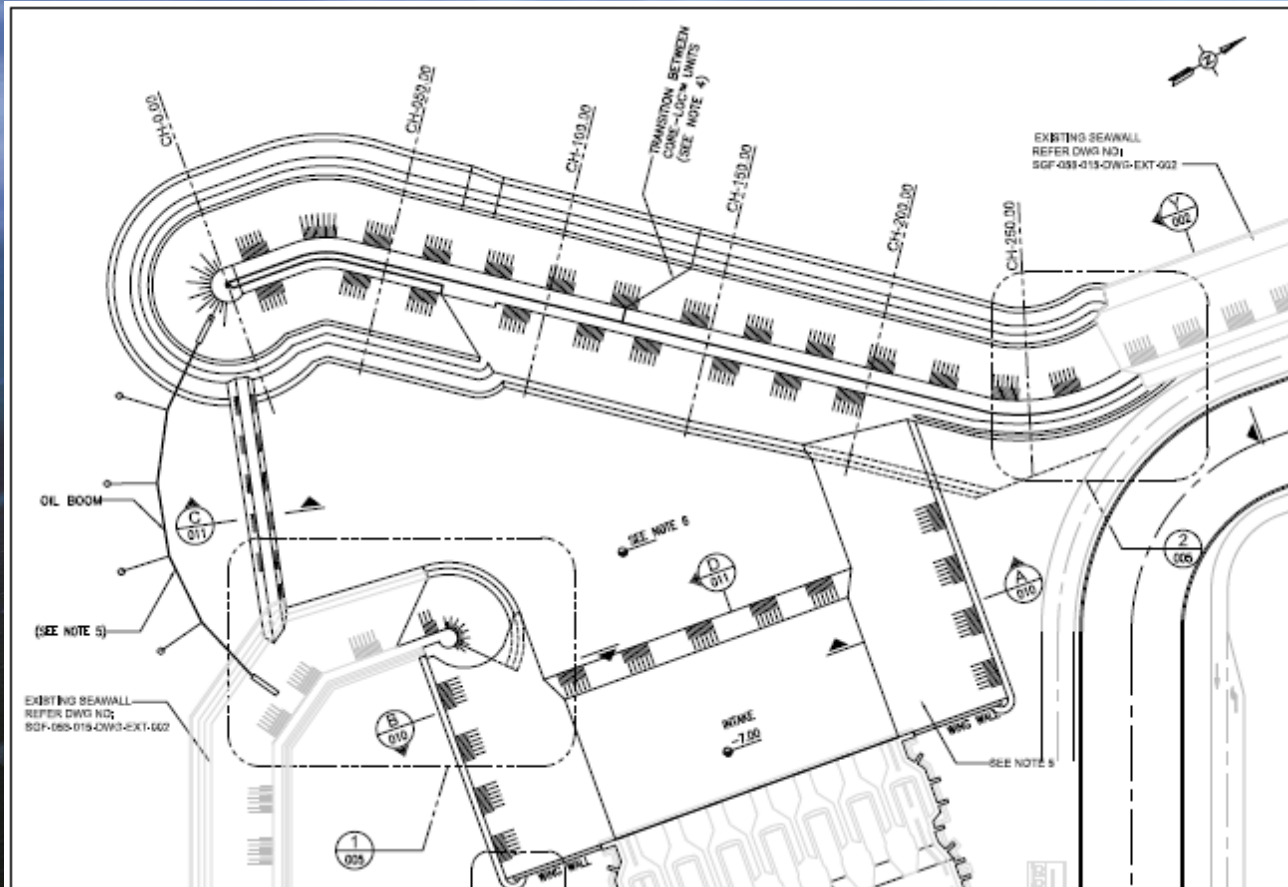

▶ Airflex Boom



▶ Liteflex Boom



▶ Seaflex Boom



▶ SeaReel



▶ SeaReel



▶ Floating Storage



▶ Tear Drop Tanks



▶ Dispersant Spray



▶ IMO Training



- ▶ Containment & Storage

Previous Technologies

- ▶ RBS TRITON™ Technology
- ▶ Open Water Solutions
- ▶ Global Activity

AQUA-GUARD

▶ Aqua-Weir 1



▶ Aqua-Weir 1



AQUA[®]GUARD

▶ Aqua-Weir 30-100

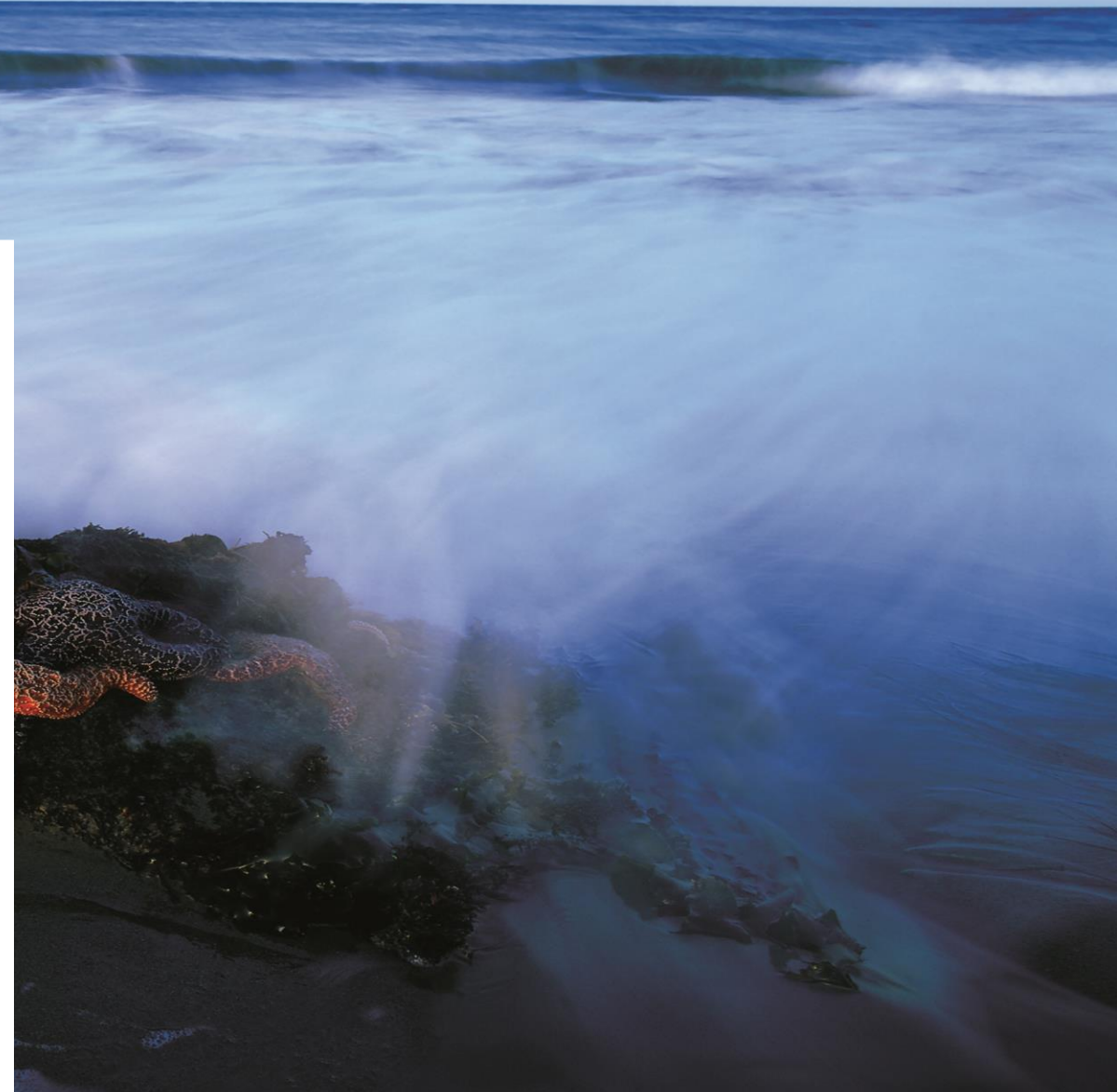

AQUA GUARD

▶ Aqua-Weir 30-100



AQUA GUARD

▶ Aqua-Weir 125-300



AQUA GUARD

▶ Aqua-Weir 125-300



- ▶ Containment & Storage
- ▶ Previous Technologies

RBS TRITON™ Technology

- ▶ Open Water Solutions
- ▶ Global Activity

▶ RBS TRITON™ > 300%



(12) **United States Patent**
Pertile et al.

(10) Patent No.: **US 7,303,688 B2**
(45) Date of Patent: **Dec. 4, 2007**

(54) **OIL SKIMMER AND METHOD OF OPERATING SAME**

(75) Inventors: Lawrence Pertile, North Vancouver (CA); Cameron Stewart Jantz, North Vancouver (CA)

(73) Assignee: Aqua-Guard Spill Response Inc.

(*) Notice: Subject to any disclaimer, the term of this patent is extended or adjusted under 35 U.S.C. 154(b) by 31 days.

(21) Appl. No.: 11/286,139

(22) Filed: Nov. 23, 2005

(65) **Prior Publication Data**
US 2007/0114189 A1 May 24, 2007

(51) Int. Cl. **H02B 15/04** (2006.01)

(52) U.S. Cl. 210/776, 210/242.3, 210/923

(58) **Field of Classification Search** 210/776, 210/923, 242.1, 242.3, 242.4, 934
See application file for complete search history.

(56) **References Cited**

U.S. PATENT DOCUMENTS

3,426,802 A	*	2/1966	Bauer et al.	210/776
3,539,508 A	*	11/1970	Bulky et al.	210/242.4
3,612,277 A	*	10/1971	Van Slaven et al.	210/776
3,617,555 A	*	11/1971	Ginsburgh et al.	210/242.4
3,670,896 A	*	6/1972	Hale et al.	210/242.3
4,061,569 A	*	12/1977	Bennett et al.	210/923
4,363,735 A	*	12/1982	Hook	210/776
4,366,122 A	*	1/1983	Ravagnani	210/242.3
4,514,299 A	*	4/1985	Ayrolti	210/923
5,085,770 A	*	2/1992	Eberhardt	210/242.3
5,173,182 A	*	12/1992	Debelium	210/242.3

* cited by examiner

Primary Examiner—Christopher Upton
(74) *Attorney, Agent, or Firm*—John Russell Uren

(57) **ABSTRACT**

A skimmer used to remove both heavy and light oil from a body of water or for the removal of either light or heavy oil and a method of operation of the skimmer. The heavier oil is removed from a first location on a rotating member and the lighter oil is removed from a second location on the rotating member. The oil removed at both locations is collected at a single location and a pump removes the oil from the skimmer.

23 Claims, 6 Drawing Sheets

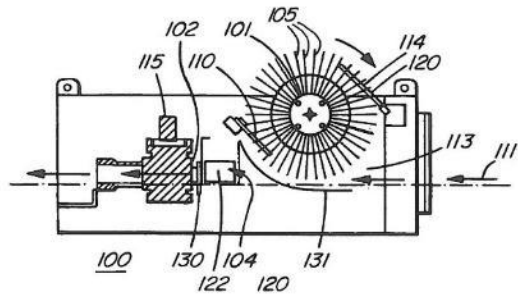

U.S. Patent Dec. 4, 2007 Sheet 1 of 6 US 7,303,688 B2

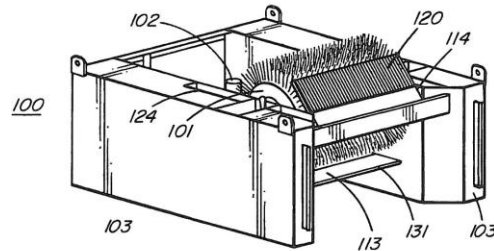

FIG. 1A

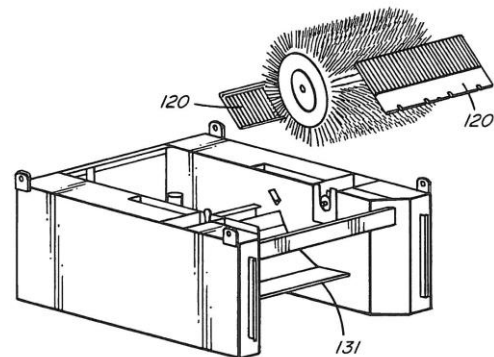
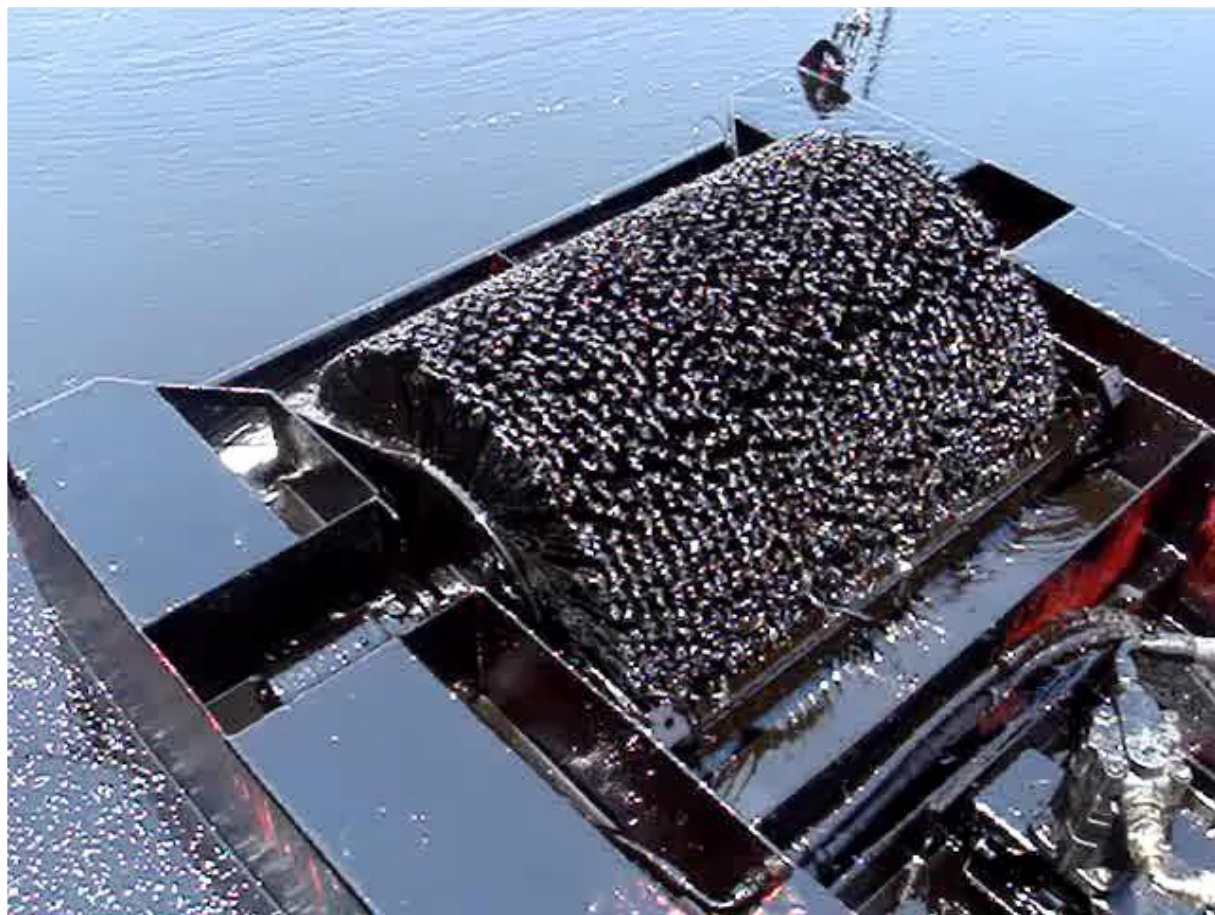

FIG. 1B

▶ RBS TRITON™ Technology



AQUA GUARD

▶ RBS TRITON™ Technology

Aqua-Guard Soil Remediation Inc.
Extra Heavy Oil Test
RBS TRITON™ Advanced Technology



- ▶ Containment & Storage
- ▶ RBS TRITON™ Technology

Protected & Calm Water Solutions

- ▶ Open Water Solutions
- ▶ Global Activity

AQUA GUARD

▶ RBS TRITON™ 35



AQUA GUARD

▶ RBS TRITON™ 35



AQUA-GUARD

▶ RBS TRITON™ 35



AQUA GUARD

▶ RBS TRITON™ 60



AQUA GUARD



AQUA GUARD

▶ RBS TRITON™ 60



AQUA GUARD

▶ RBS TRITON™ 60 SS

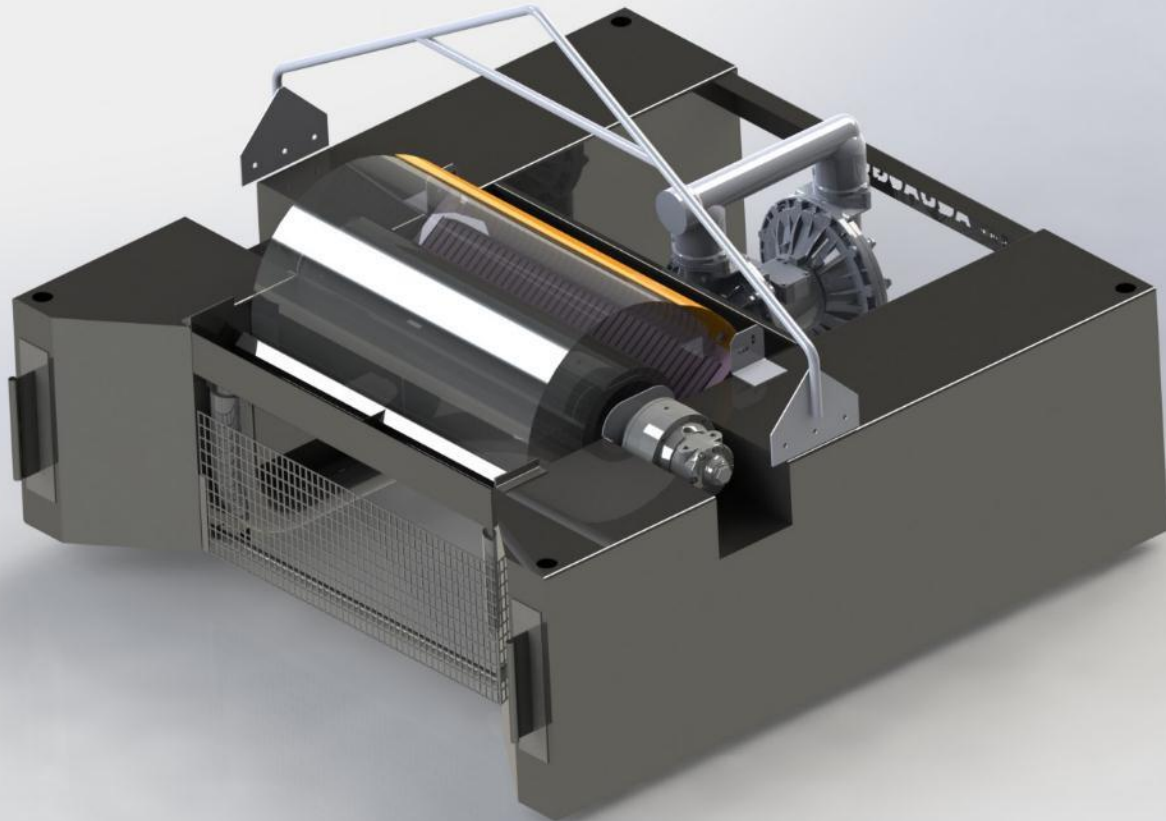

▶ RBS TRITON™ 150



AQUA GUARD

▶ RBS TRITON™ 150

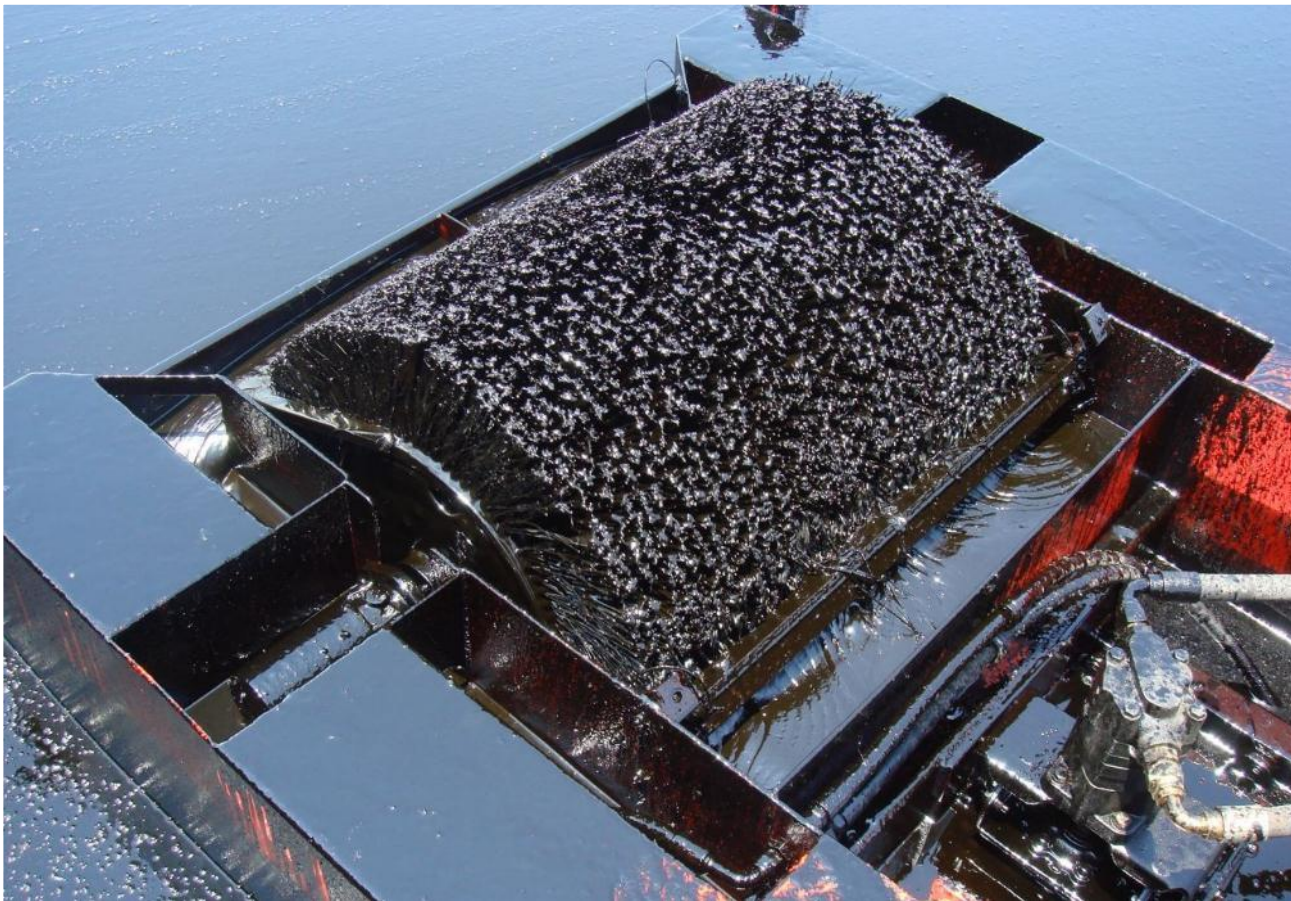

AQUA-GUARD

▶ RBS TRITON™ 150

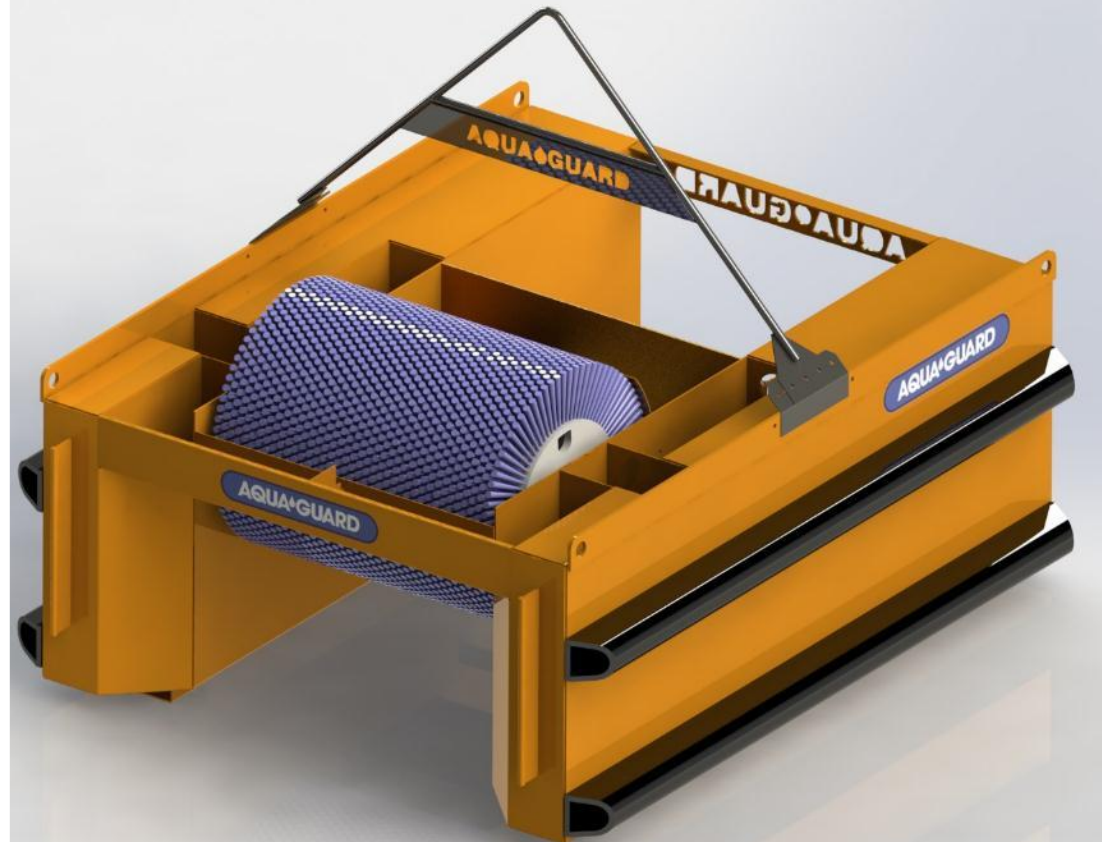
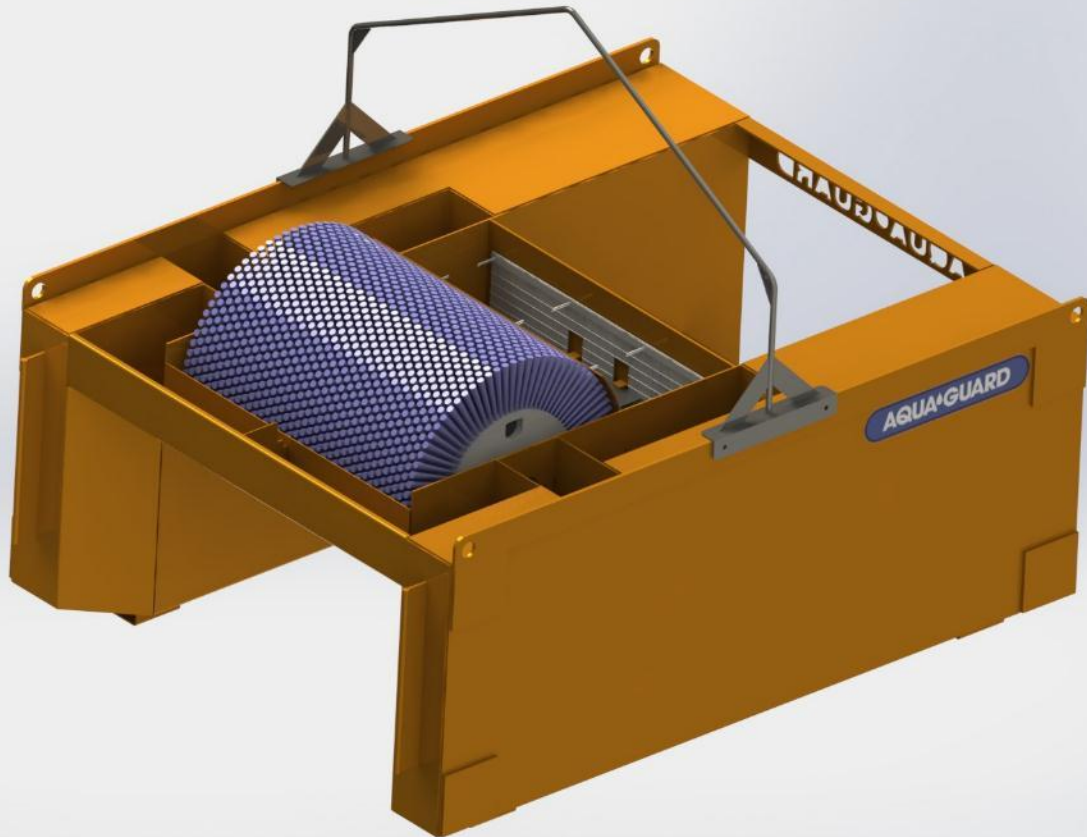

▶ RBS TRITON™ 150 T



AQUA GUARD

▶ RBS TRITON™ 150 T



AQUA GUARD

▶ RBS TRITON™ 150 T



- ▶ RBS TRITON™ Technology
- ▶ Protected & Calm Water Solutions

Open Water Solutions

- ▶ Global Activity

► Equipment History



► Consub OSR - Brazil



Norsul Marati
Aracaju, Brazil

▶ RBS TRITON™ 150 OS



AQUA-GUARD

▶ RBS TRITON™ 150 OS



▶ RBS TRITON™ 150 OS

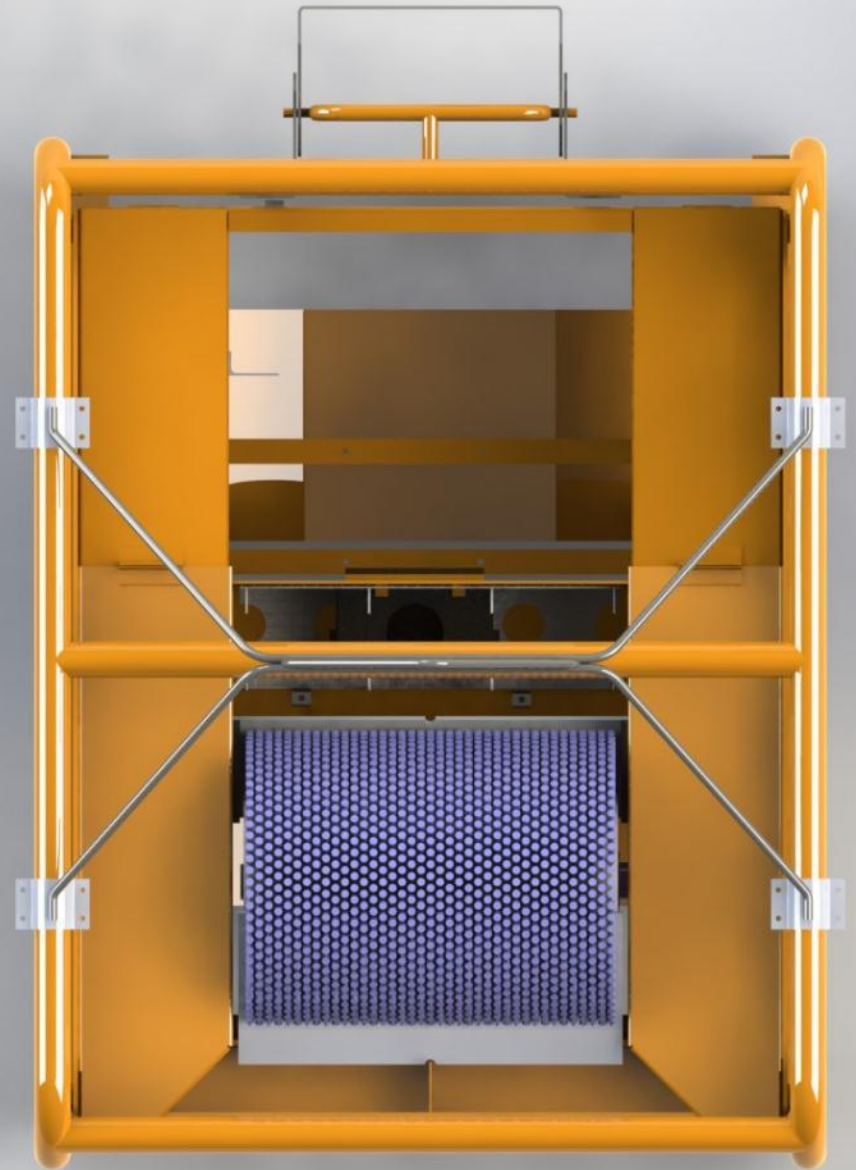
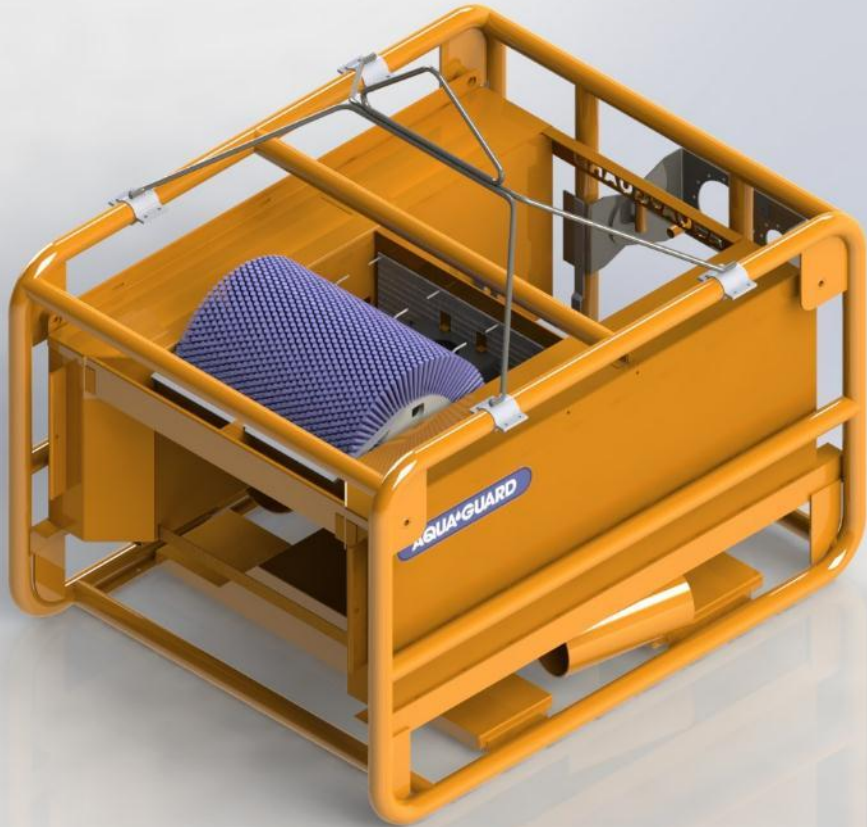

AQUA GUARD

▶ RBS TRITON™ 300 OS



AQUA GUARD

▶ RBS TRITON™ 300 OS

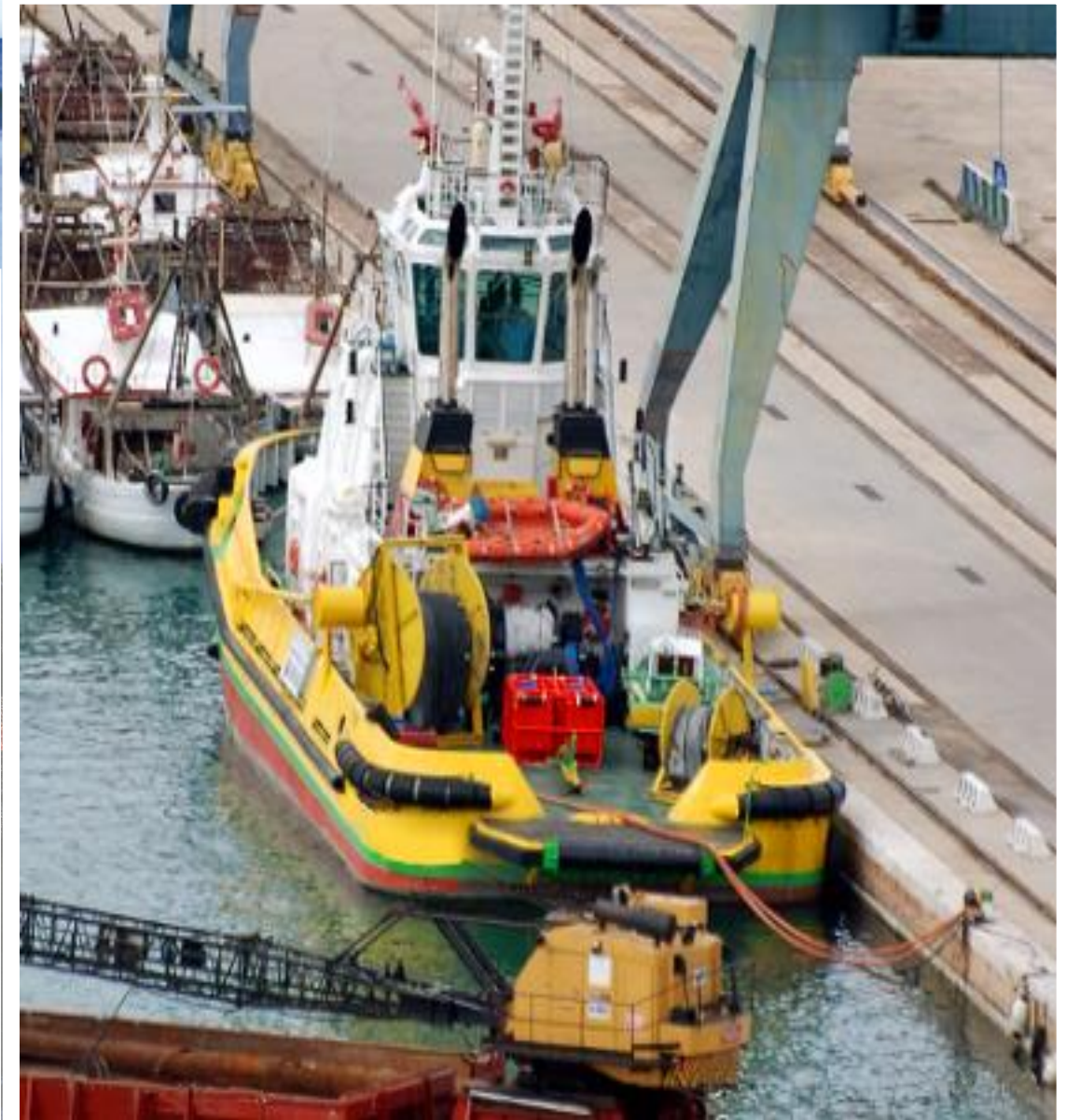

▶ URO 300 System



AQUA GUARD

▶ URO 300 System



AQUA GUARD

▶ URO 600 System

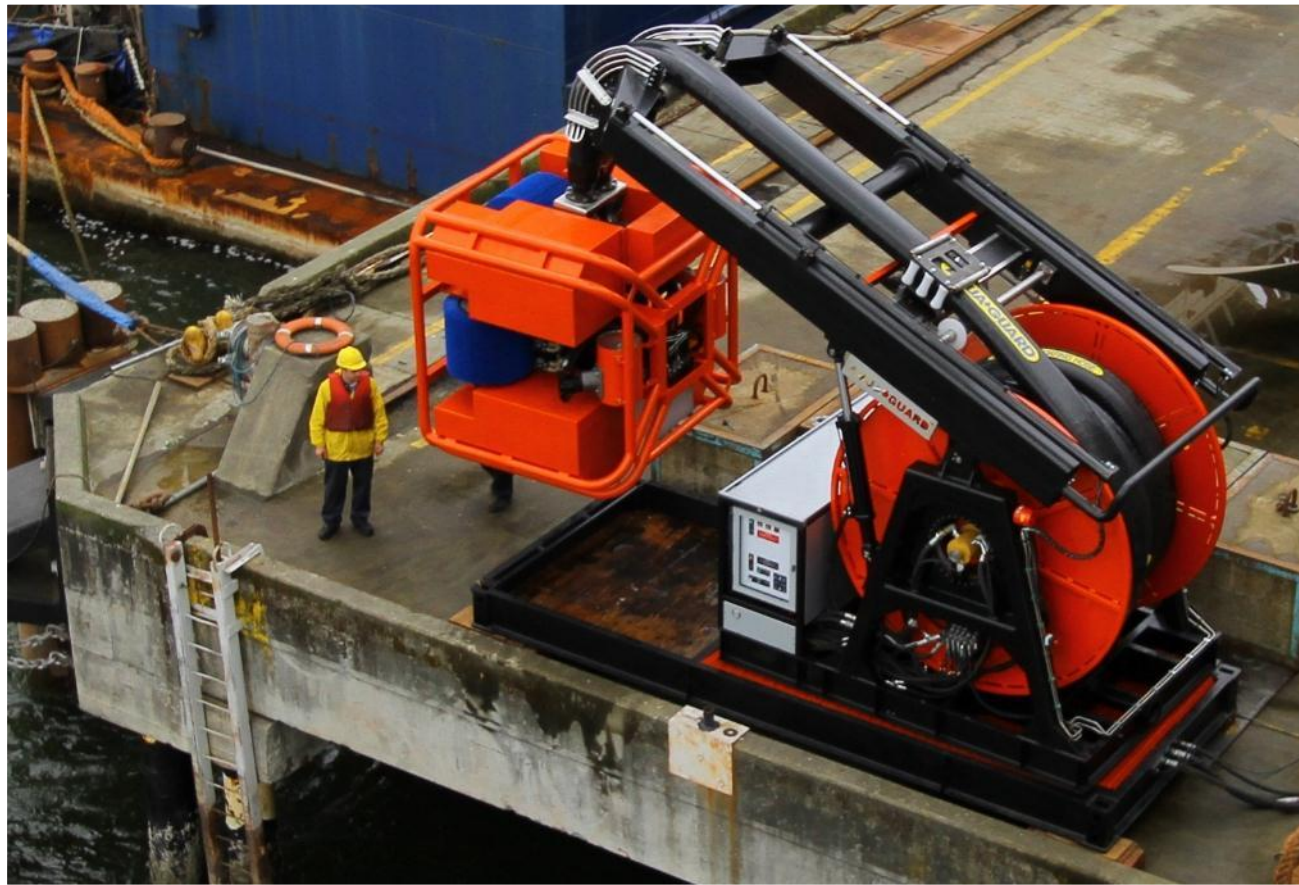

AQUAGUARD

▶ URO 600 System

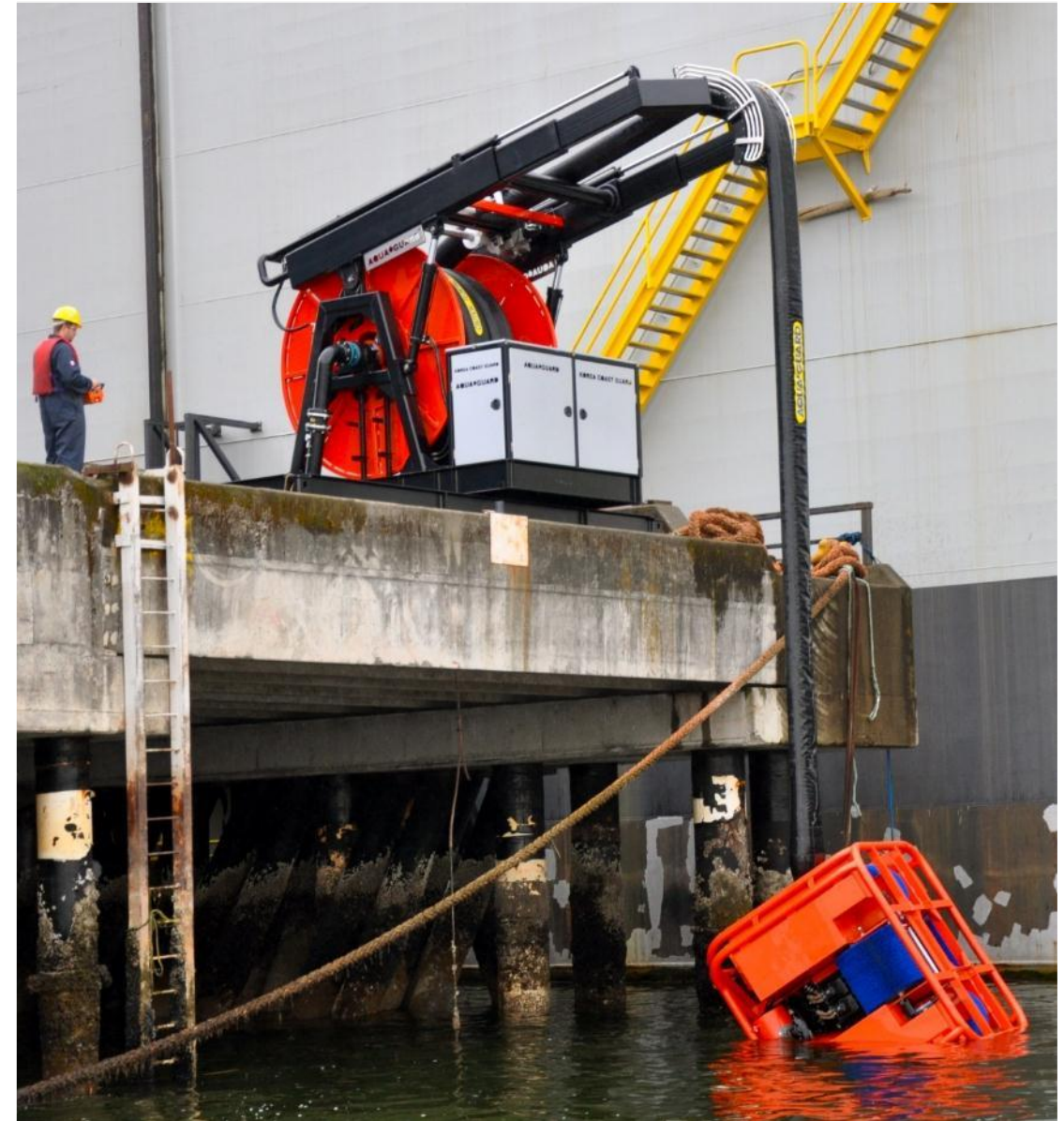

AQUA[®]GUARD

▶ RBS TRITON™ Technology



- ▶ Protected & Calm Water Solutions
- ▶ Open Water Solutions

Global Activity

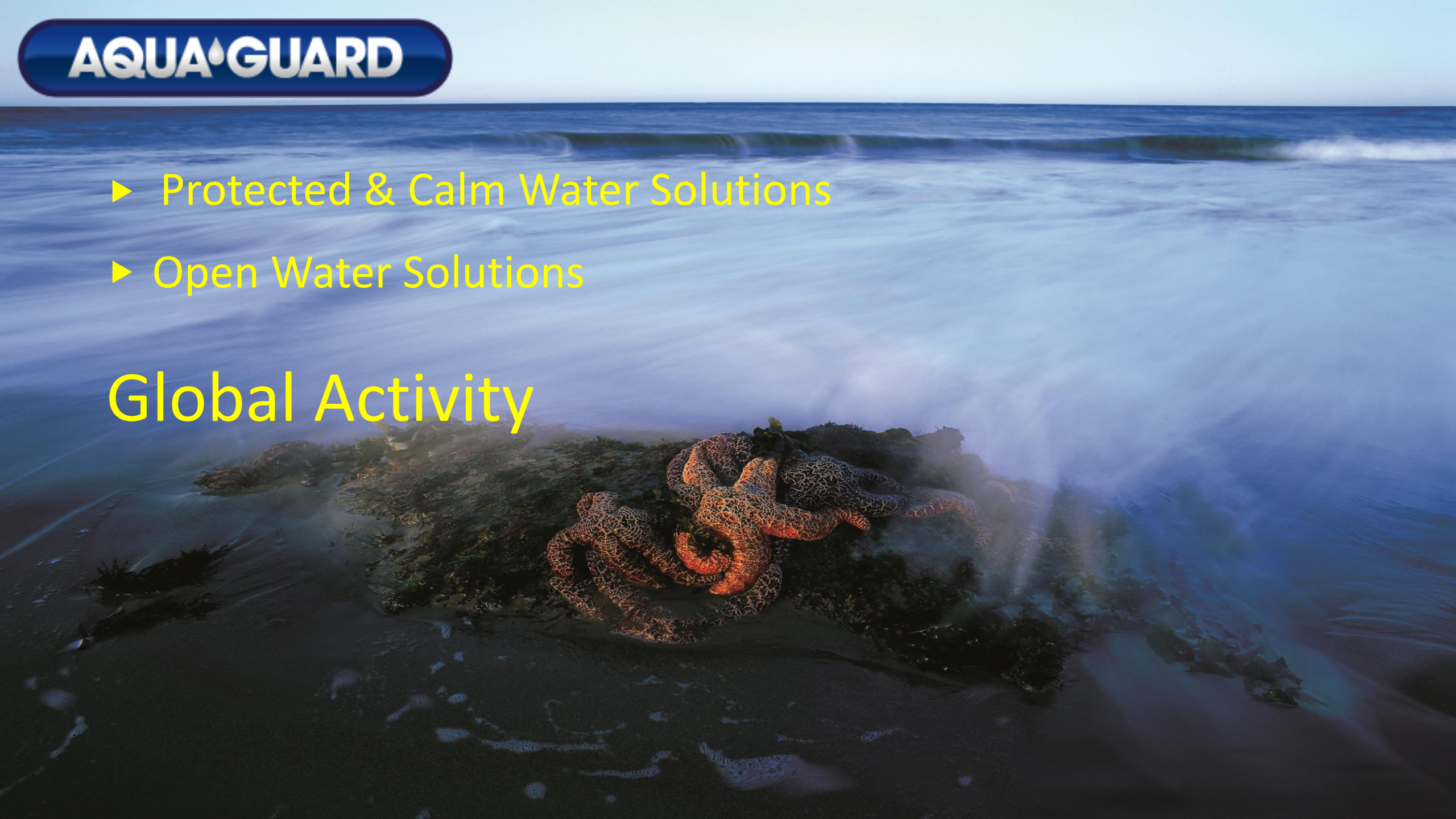

► Experience



Pipeline Spill
Burnaby, Canada



Clean Caribbean Co-op (OSRL)
Ft. Lauderdale, USA

2006 11

► Experience



Shell API Separator
Seria, Brunei



Bachaquero Oil Spill
Maracaibo, Venezuela

AQUA⁺GUARD

▶ BP Horizon



BP Horizon – 100 Skimming Systems Shipped to Gulf of Mexico

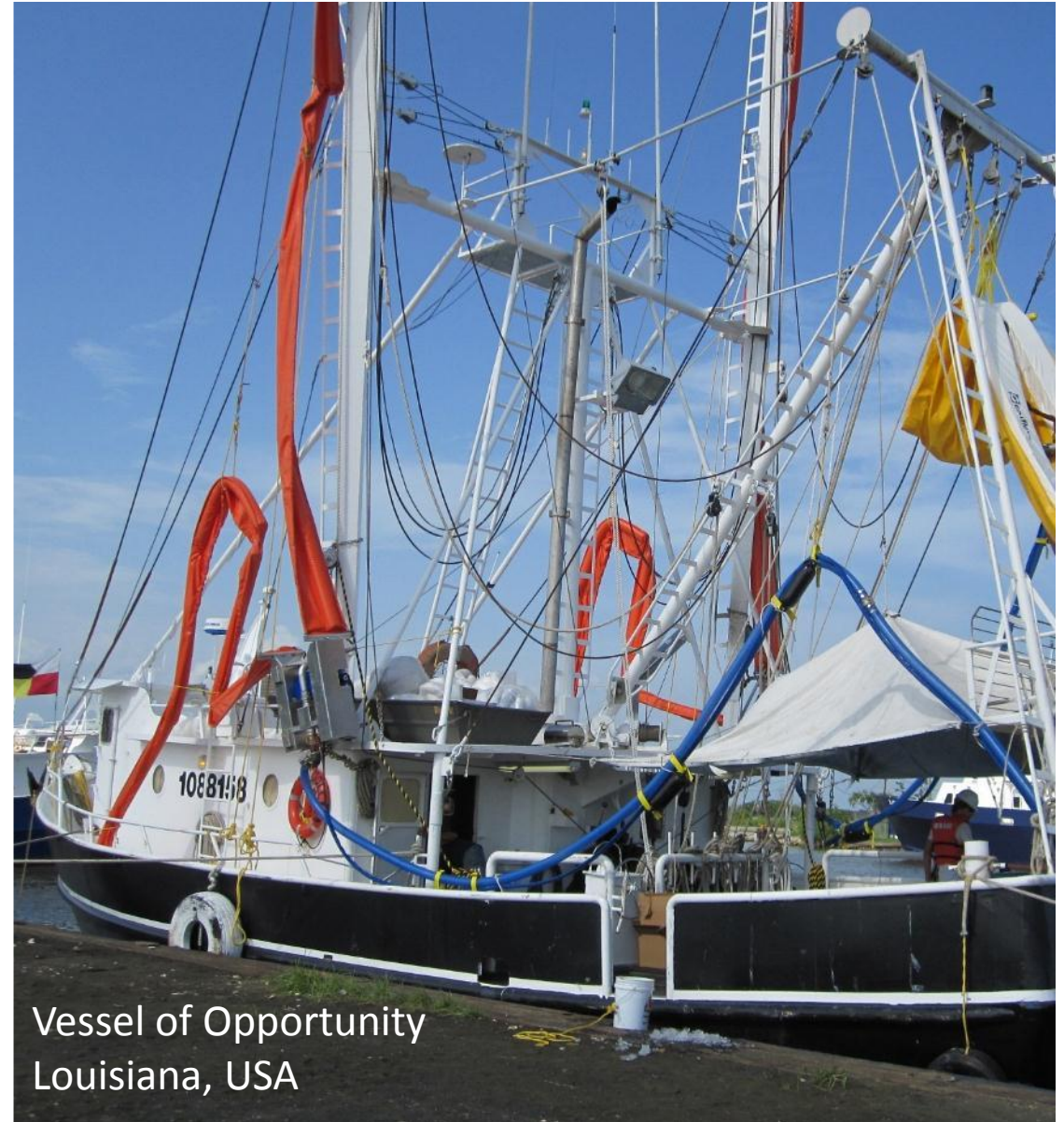

Vessel of Opportunity
Louisiana, USA

► Sao Miguel / Rolls Royce



URO 300

Mar Limpo II (First of a Series of Modern OSRV's Built in Brazil)

Rio De Janeiro, Brazil

► Sao Miguel / Rolls Royce



Rolls-Royce

UT-Design™

UT 535 E

Oil Spill Response Vessel

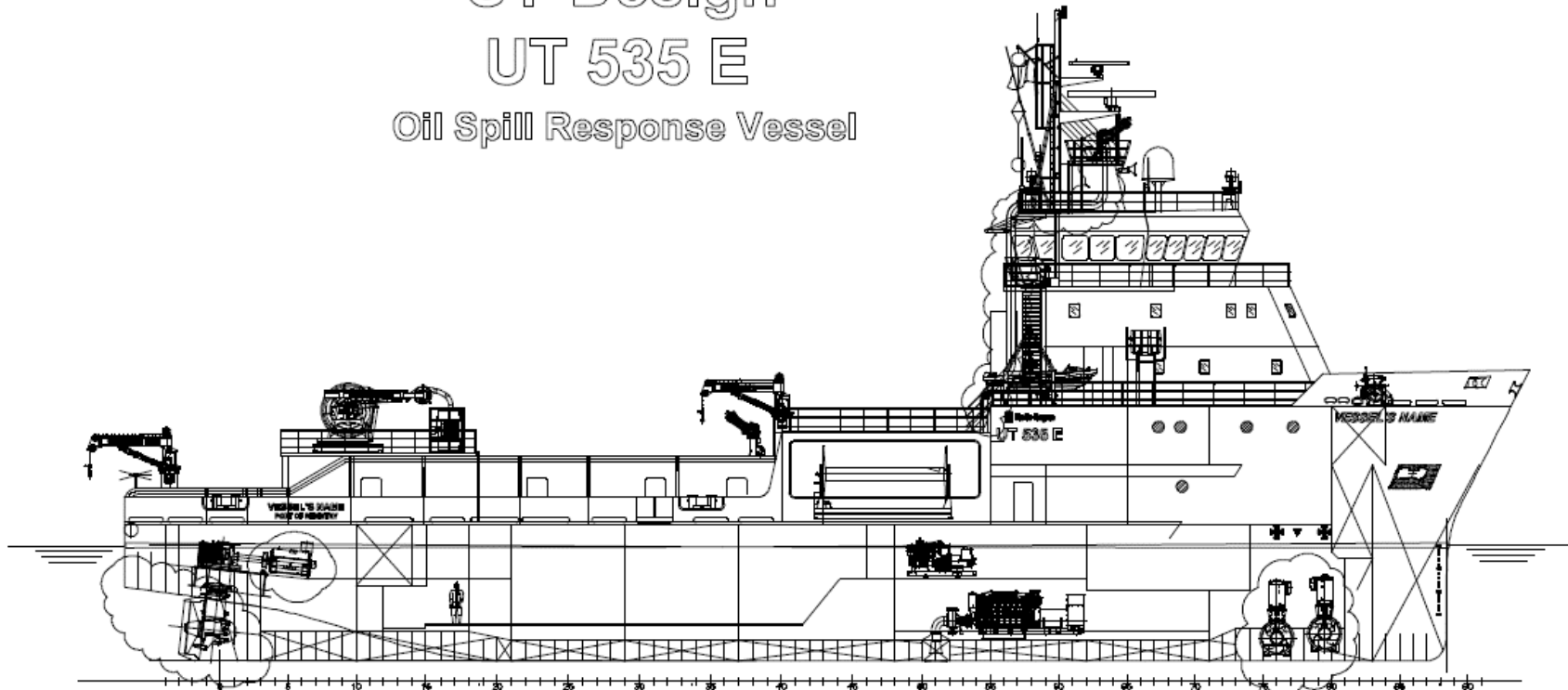

AQUA GUARD

▶ Sao Miguel
Brazil

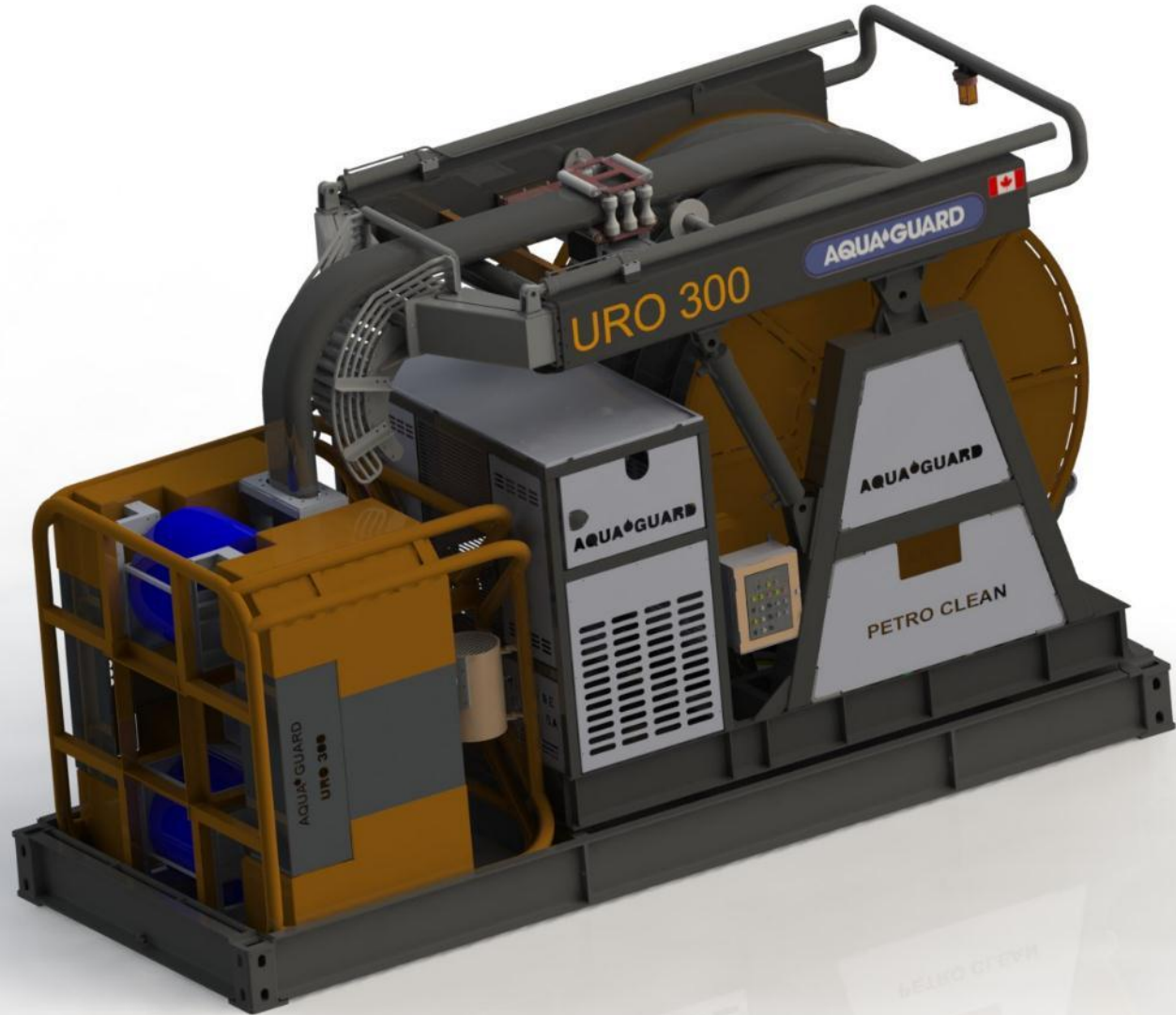

▶ STX Offshore & Shipbuilding



STX / Korea Coast Guard
Pusan, South Korea

▶ STX Offshore & Shipbuilding

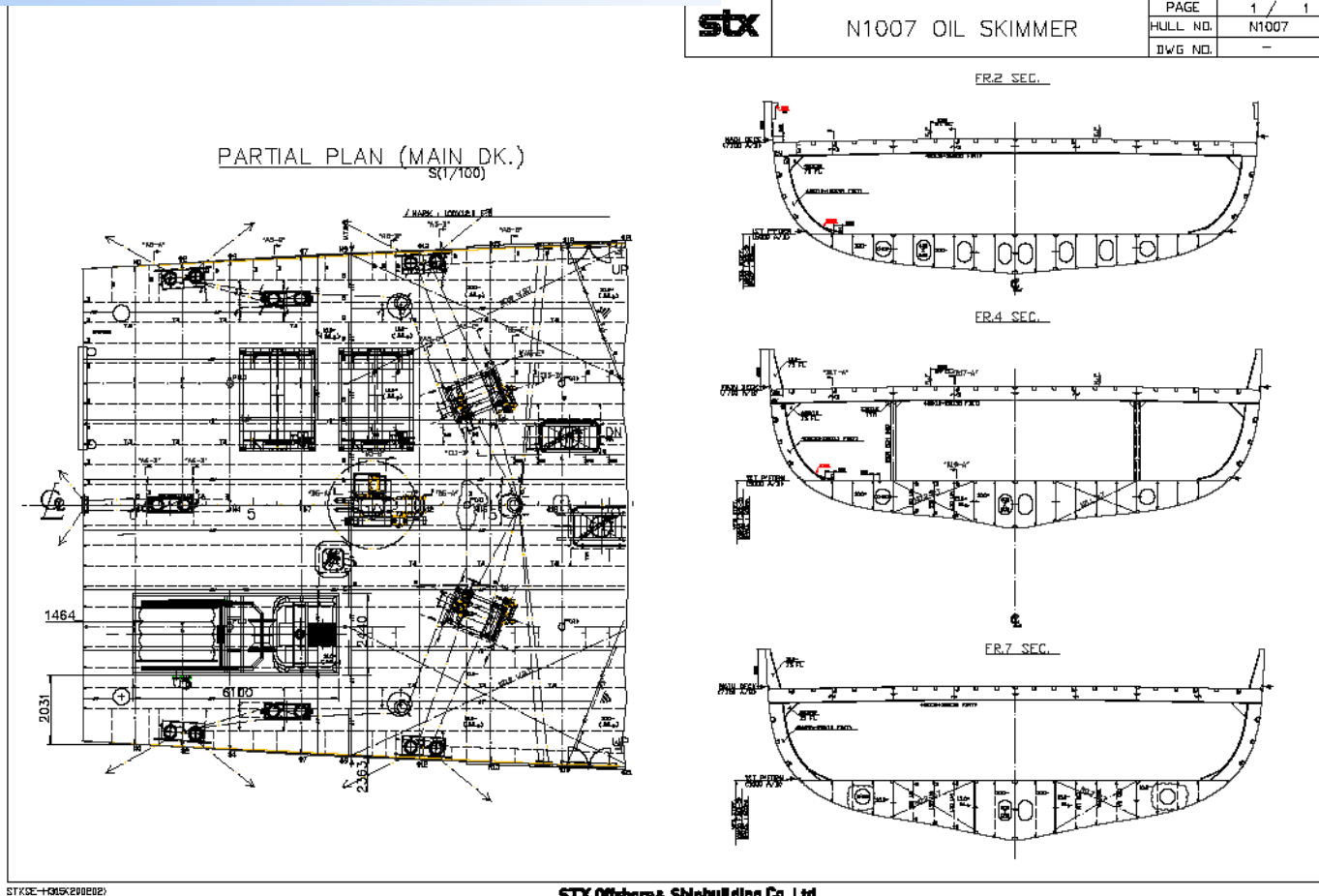

AQUA[®]GUARD

STX Offshore

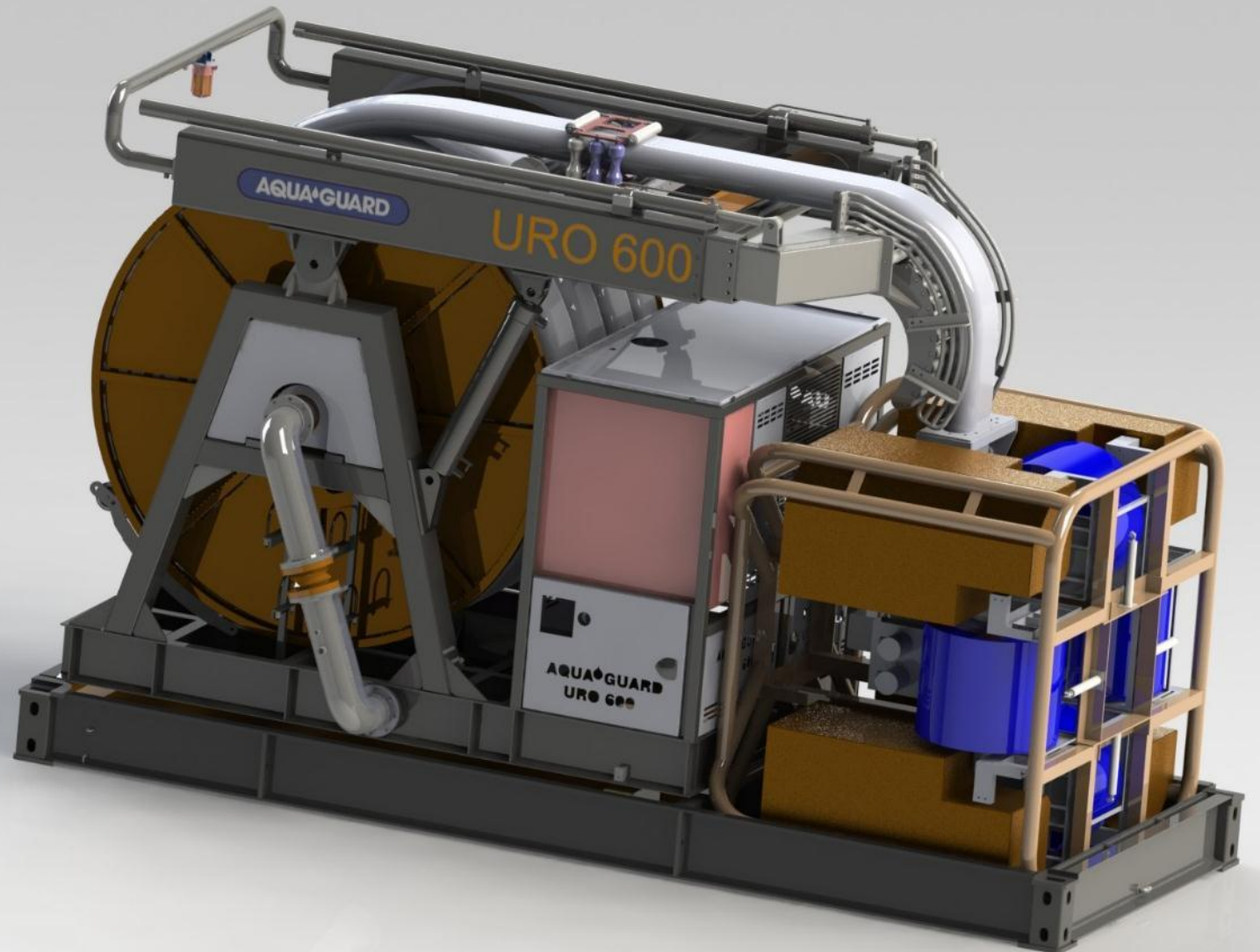

► Costa Concordia



Costa Concordia, Italy



Fratelli Neri, Italy